

DATA SHEET

PMEGX10BEA; PMEGX10BEV

1 A very low V_F MEGA Schottky
barrier rectifier

Product specification
Supersedes data of 2004 Apr 02

2004 Jun 14

1 A very low V_F MEGA Schottky barrier rectifier

PMEGXX10BEA; PMEGXX10BEV

FEATURES

- Forward current: 1 A
- Reverse voltages: 20 V, 30 V, 40 V
- Very low forward voltage
- Ultra small and very small plastic SMD package
- Power dissipation comparable to SOT23.

APPLICATIONS

- High efficiency DC-to-DC conversion
- Voltage clamping
- Protection circuits
- Low voltage rectification
- Blocking diodes
- Low power consumption applications.

DESCRIPTION

Planar Maximum Efficiency General Application (MEGA) Schottky barrier rectifier with an integrated guard ring for stress protection, encapsulated in a very small SOD323 (SC-76) and ultra small SOT666 SMD plastic package.

MARKING

TYPE NUMBER	MARKING CODE
PMEG2010BEA	V1
PMEG3010BEA	V2
PMEG4010BEA	V3
PMEG2010BEV	G6
PMEG3010BEV	G5
PMEG4010BEV	G4

QUICK REFERENCE DATA

SYMBOL	PARAMETER	MAX.	UNIT
I_F	forward current	1	A
V_R	reverse voltage	20; 30; 40	V

PINNING

PIN	DESCRIPTION
PMEGXX10BEA (see Fig.1)	
1	cathode
2	anode
PMEGXX10BEV (see Fig.2)	
1, 2, 5, 6	cathode
3, 4	anode

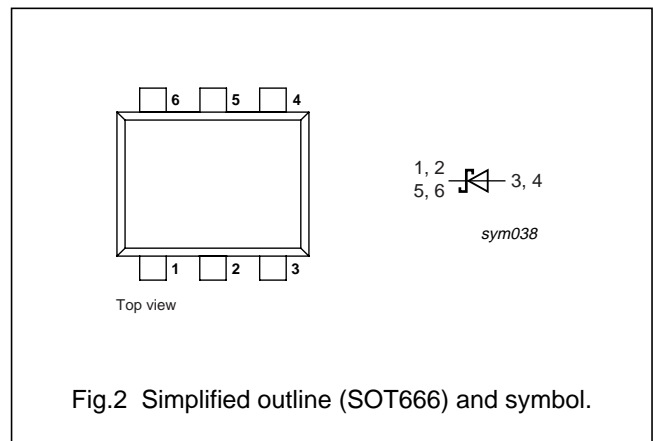
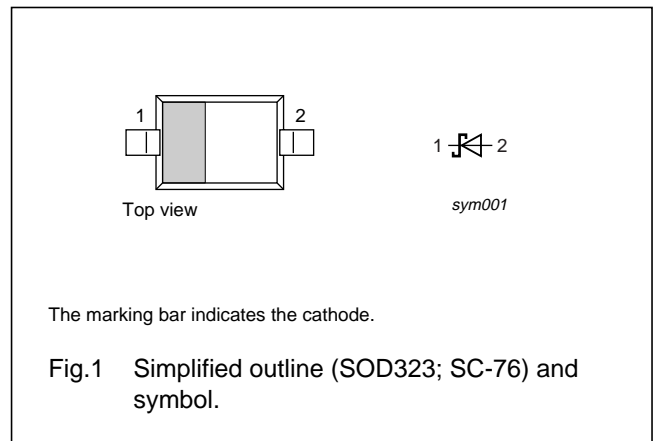

1 A very low V_F MEGA Schottky barrier rectifier

PMEGXX10BEA;
PMEGXX10BEV

ORDERING INFORMATION

TYPE NUMBER	PACKAGE		
	NAME	DESCRIPTION	VERSION
PMEGXX10BEA	–	plastic surface mounted package; 2 leads	SOD323
PMEGXX10BEV		plastic surface mounted package; 6 leads	SOT666

LIMITING VALUES

In accordance with the Absolute Maximum Rating System (IEC 60134).

SYMBOL	PARAMETER	CONDITIONS	MIN.	MAX.	UNIT
V_R	continuous reverse voltage PMEG2010BEA/PMEG2010BEV PMEG3010BEA/PMEG3010BEV PMEG4010BEA/PMEG4010BEV		–	20 30 40	V V V
I_F	continuous forward current	$T_s \leq 55\text{ °C}$; note 1	–	1	A
I_{FRM}	repetitive peak forward current	$t_p \leq 1\text{ ms}$; $\delta \leq 0.5$; note 2	–	3.5	A
I_{FSM}	non-repetitive peak forward current	$t_p = 8\text{ ms}$; square wave; note 2	–	10	A
T_j	junction temperature	note 3	–	150	°C
T_{amb}	operating ambient temperature	note 3	–65	+150	°C
T_{stg}	storage temperature		–65	+150	°C

Notes

1. Refer to SOD323 (SC-76) and SOT666 standard mounting conditions.
2. Only valid if pins 3 and 4 are connected in parallel (SOT666 package).
3. For Schottky barrier diodes thermal runaway has to be considered, as in some applications the reverse power losses P_R are a significant part of the total power losses. Nomograms for determining the reverse power losses P_R and $I_{F(AV)}$ rating will be available on request.

1 A very low V_F MEGA Schottky barrier rectifier

PMEGXX10BEA; PMEGXX10BEV

THERMAL CHARACTERISTICS

SYMBOL	PARAMETER	CONDITIONS	VALUE	UNIT
PMEGXX10BEA (SOD323)				
$R_{th(j-a)}$	thermal resistance from junction to ambient	in free air; notes 1 and 2	450	K/W
		in free air; notes 2 and 3	210	K/W
$R_{th(j-s)}$	thermal resistance from junction to soldering point	note 4	90	K/W
PMEGXX10BEV (SOT666)				
$R_{th(j-a)}$	thermal resistance from junction to ambient	in free air; notes 2 and 5	405	K/W
		in free air; notes 2 and 6	215	K/W
$R_{th(j-s)}$	thermal resistance from junction to soldering point	note 4	80	K/W

Notes

1. Refer to SOD323 (SC-76) standard mounting conditions.
2. For Schottky barrier diodes thermal runaway has to be considered, as in some applications the reverse power losses P_R are a significant part of the total power losses. Nomograms for determining the reverse power losses P_R and $I_{F(AV)}$ rating will be available on request.
3. Device mounted on an FR4 printed-circuit board with copper clad 10×10 mm.
4. Solder point of cathode tab.
5. Refer to SOT666 standard mounting conditions.
6. Only valid if pins 3 and 4 are connected in parallel (SOT666 package).

CHARACTERISTICS

$T_{amb} = 25$ °C unless otherwise specified.

SYMBOL	PARAMETER	CONDITIONS	PMEG2010BEA/ PMEG2010BEV		PMEG3010BEA/ PMEG3010BEV		PMEG4010BEA/ PMEG4010BEV		UNIT
			TYP.	MAX.	TYP.	MAX.	TYP.	MAX.	
V_F	forward voltage	$I_F = 0.1$ mA	90	130	90	130	95	130	mV
		$I_F = 1$ mA	150	190	150	200	155	210	mV
		$I_F = 10$ mA	210	240	215	250	220	270	mV
		$I_F = 100$ mA	280	330	285	340	295	350	mV
		$I_F = 500$ mA	355	390	380	430	420	470	mV
		$I_F = 1000$ mA	420	500	450	560	540	640	mV
I_R	continuous reverse current	$V_R = 10$ V; note 1	15	40	12	30	7	20	μ A
		$V_R = 20$ V; note 1	40	200	–	–	–	–	μ A
		$V_R = 30$ V; note 1	–	–	40	150	–	–	μ A
		$V_R = 40$ V; note 1	–	–	–	–	30	100	μ A
C_d	diode capacitance	$V_R = 1$ V; $f = 1$ MHz	66	80	55	70	43	50	pF

Note

1. Pulse test: $t_p \leq 300$ μ s; $\delta \leq 0.02$.

1 A very low V_F MEGA Schottky barrier rectifier

PMEGXX10BEA;
PMEGXX10BEV

GRAPHICAL DATA

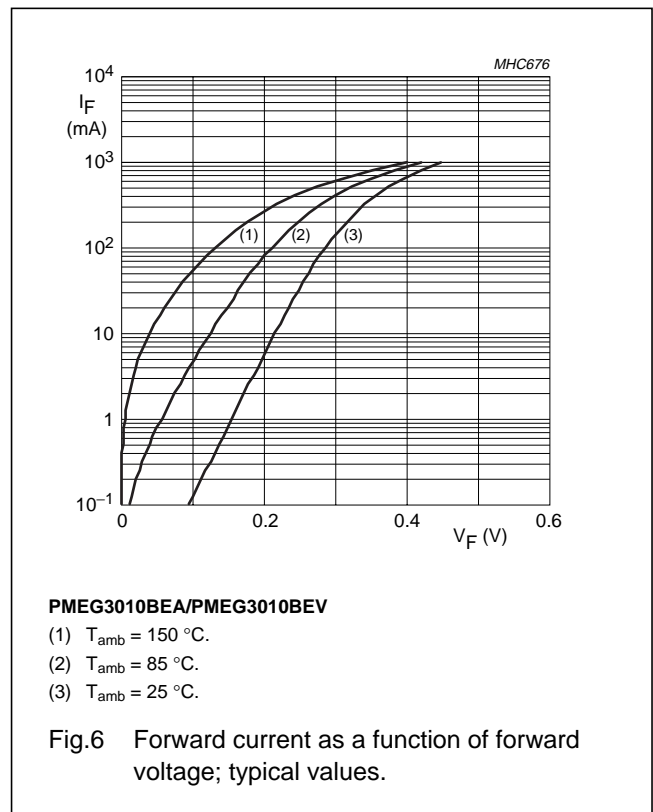
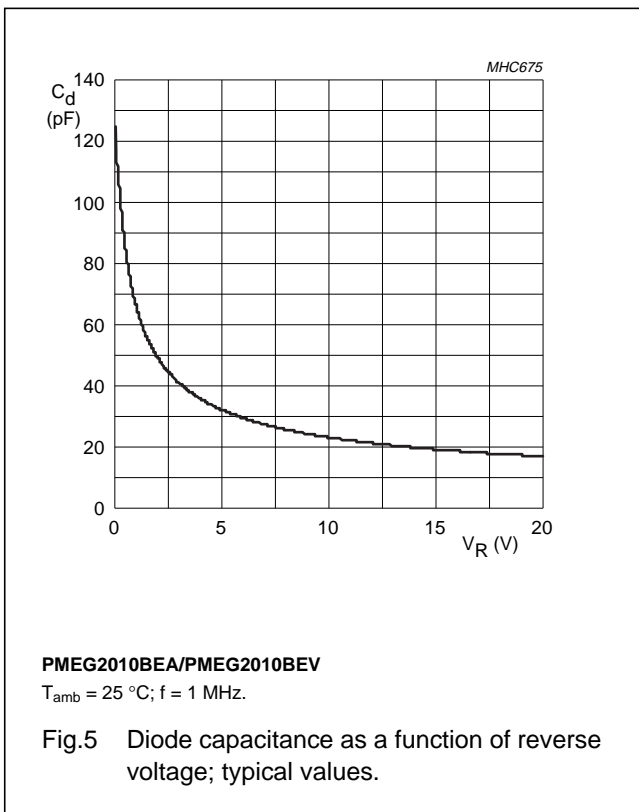
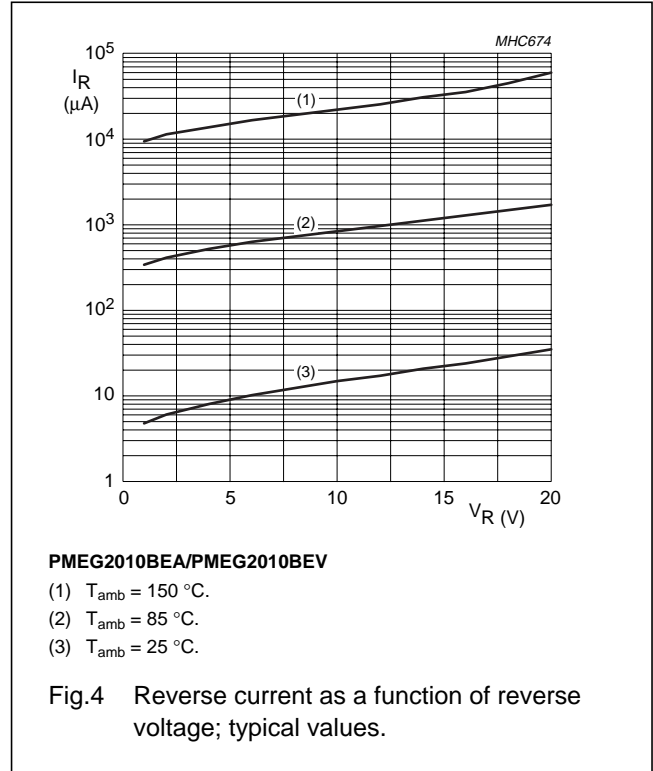
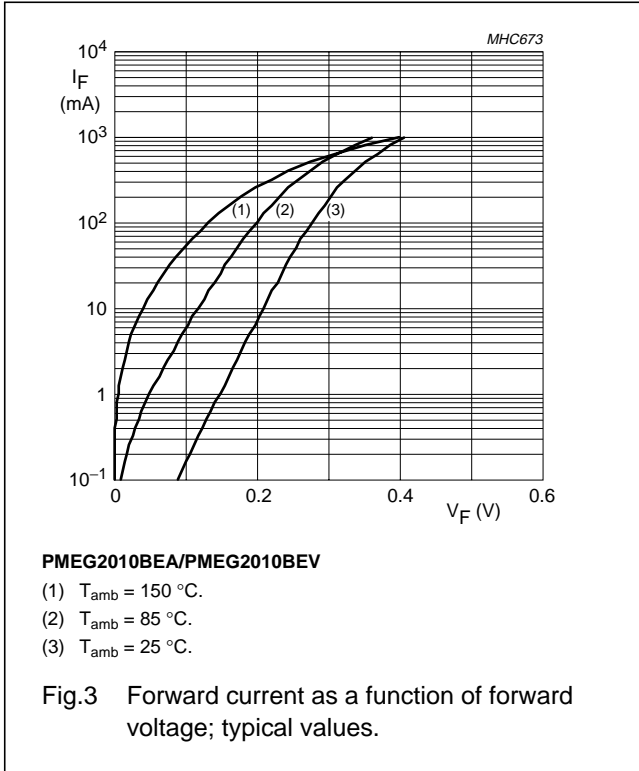

1 A very low V_F MEGA Schottky barrier rectifier

PMEGXX10BEA;
PMEGXX10BEV

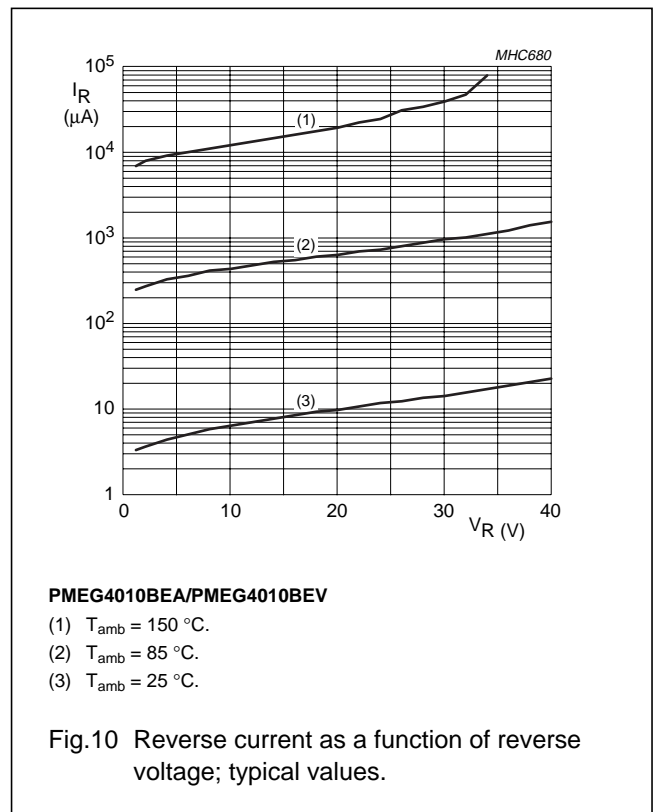
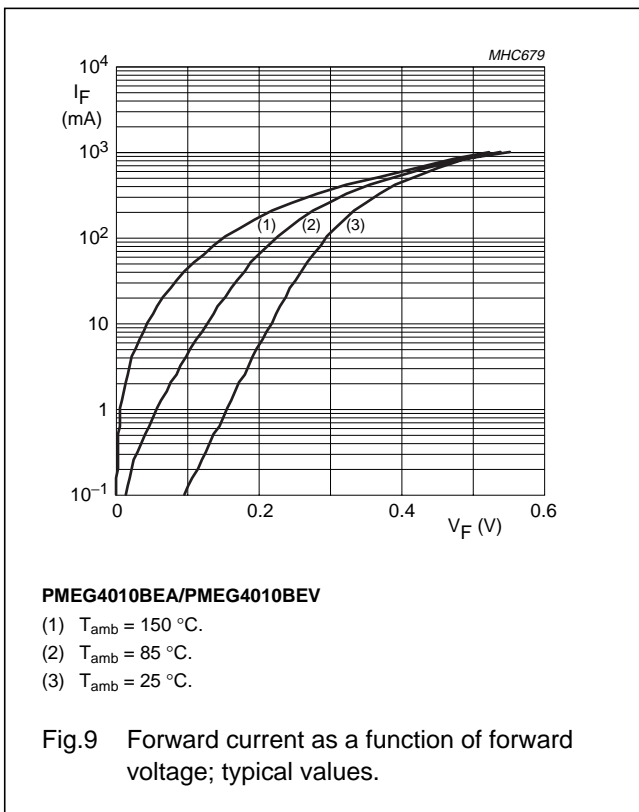
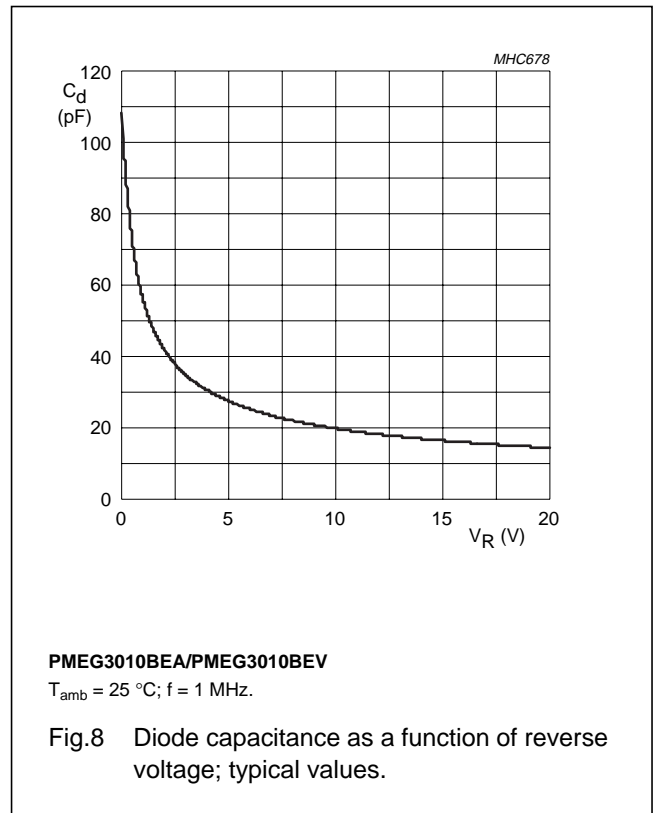
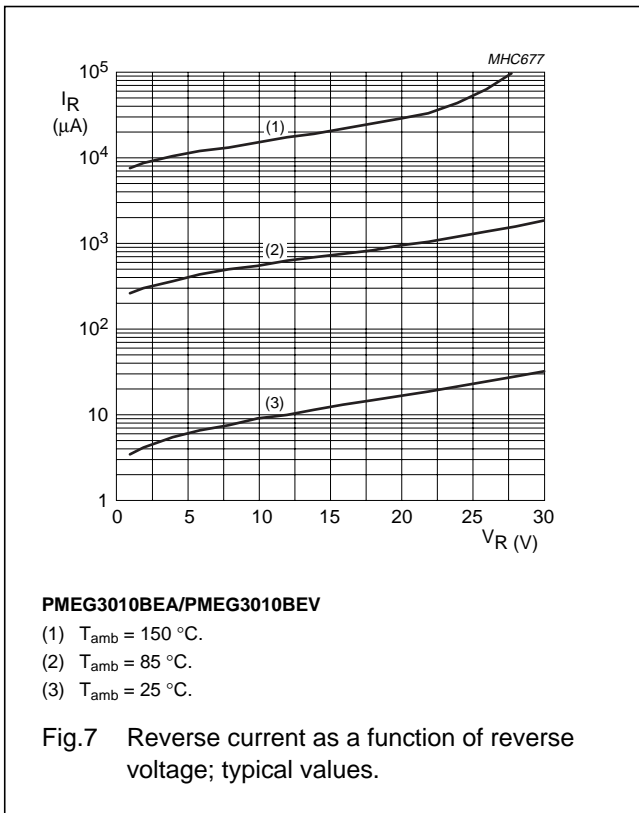

1 A very low V_F MEGA Schottky barrier rectifier

PMEGXX10BEA;
PMEGXX10BEV

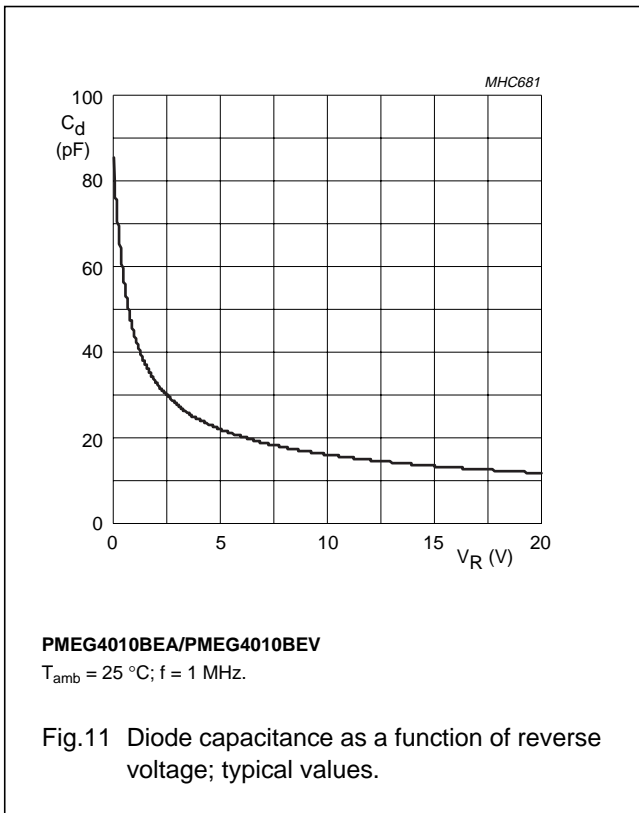

1 A very low V_F MEGA Schottky barrier rectifier

PMEGXX10BEA;
PMEGXX10BEV

PACKAGE OUTLINES

Plastic surface mounted package; 2 leads

SOD323

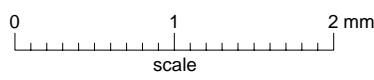
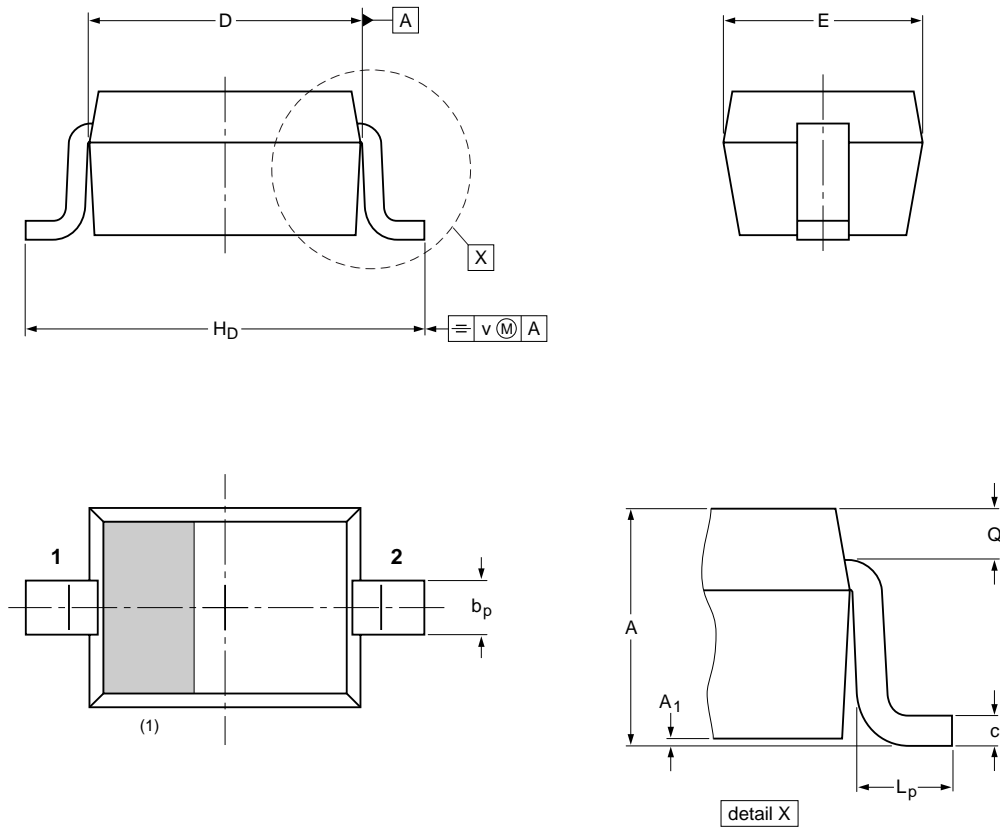

DIMENSIONS (mm are the original dimensions)

UNIT	A	A ₁ max	b _p	c	D	E	H _D	L _p	Q	v
mm	1.1 0.8	0.05	0.40 0.25	0.25 0.10	1.8 1.6	1.35 1.15	2.7 2.3	0.45 0.15	0.25 0.15	0.2

Note

1. The marking bar indicates the cathode

OUTLINE VERSION	REFERENCES				EUROPEAN PROJECTION	ISSUE DATE
	IEC	JEDEC	JEITA			
SOD323			SC-76			-99-09-13- 03-12-17

1 A very low V_F MEGA Schottky barrier rectifier

PMEGXX10BEA;
PMEGXX10BEV

Plastic surface mounted package; 6 leads

SOT666

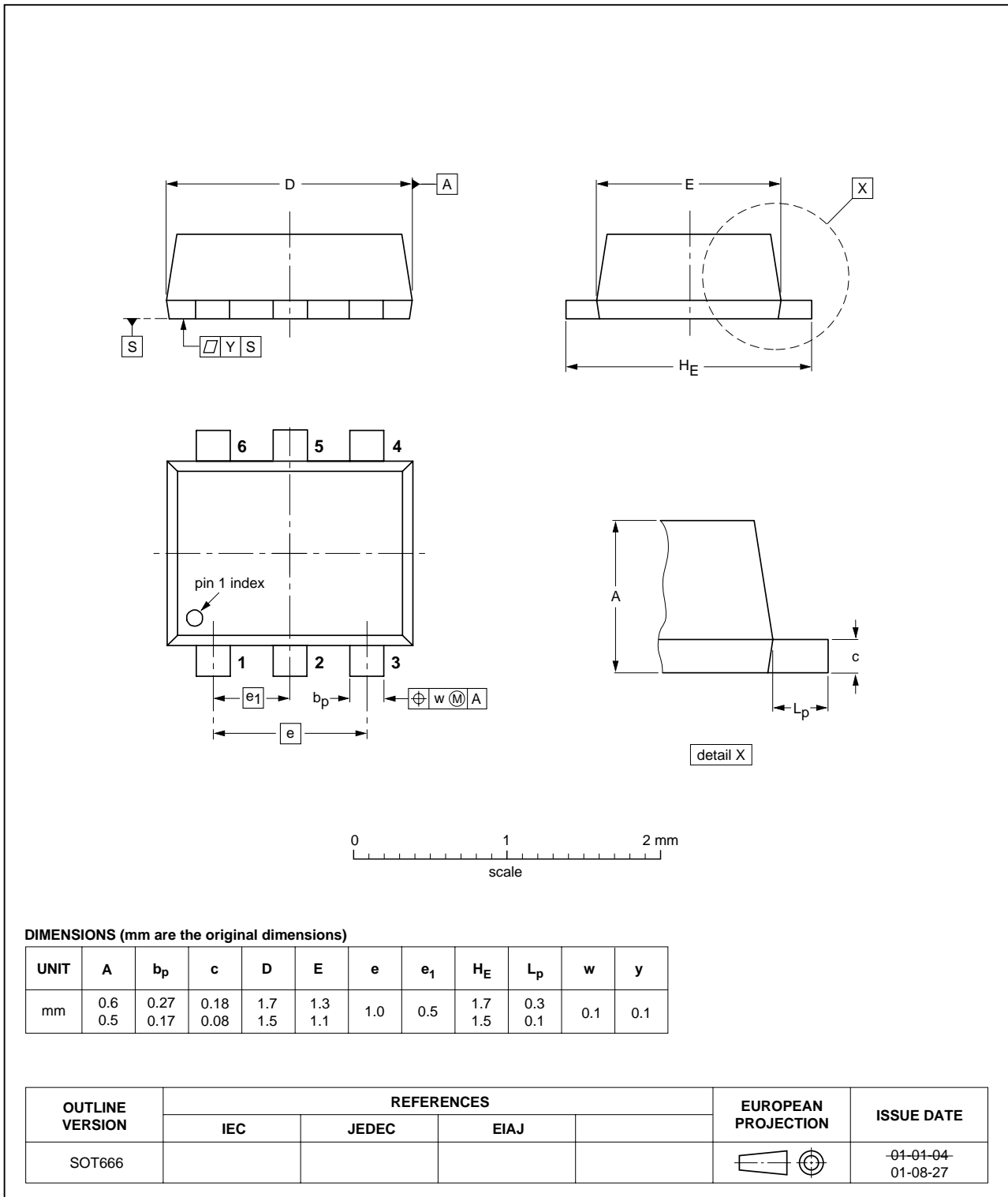

1 A very low V_F MEGA Schottky barrier rectifier

PMEGXX10BEA;
PMEGXX10BEV

DATA SHEET STATUS

LEVEL	DATA SHEET STATUS ⁽¹⁾	PRODUCT STATUS ⁽²⁾⁽³⁾	DEFINITION
I	Objective data	Development	This data sheet contains data from the objective specification for product development. Philips Semiconductors reserves the right to change the specification in any manner without notice.
II	Preliminary data	Qualification	This data sheet contains data from the preliminary specification. Supplementary data will be published at a later date. Philips Semiconductors reserves the right to change the specification without notice, in order to improve the design and supply the best possible product.
III	Product data	Production	This data sheet contains data from the product specification. Philips Semiconductors reserves the right to make changes at any time in order to improve the design, manufacturing and supply. Relevant changes will be communicated via a Customer Product/Process Change Notification (CPCN).

Notes

1. Please consult the most recently issued data sheet before initiating or completing a design.
2. The product status of the device(s) described in this data sheet may have changed since this data sheet was published. The latest information is available on the Internet at URL <http://www.semiconductors.philips.com>.
3. For data sheets describing multiple type numbers, the highest-level product status determines the data sheet status.

DEFINITIONS

Short-form specification — The data in a short-form specification is extracted from a full data sheet with the same type number and title. For detailed information see the relevant data sheet or data handbook.

Limiting values definition — Limiting values given are in accordance with the Absolute Maximum Rating System (IEC 60134). Stress above one or more of the limiting values may cause permanent damage to the device. These are stress ratings only and operation of the device at these or at any other conditions above those given in the Characteristics sections of the specification is not implied. Exposure to limiting values for extended periods may affect device reliability.

Application information — Applications that are described herein for any of these products are for illustrative purposes only. Philips Semiconductors make no representation or warranty that such applications will be suitable for the specified use without further testing or modification.

DISCLAIMERS

Life support applications — These products are not designed for use in life support appliances, devices, or systems where malfunction of these products can reasonably be expected to result in personal injury. Philips Semiconductors customers using or selling these products for use in such applications do so at their own risk and agree to fully indemnify Philips Semiconductors for any damages resulting from such application.

Right to make changes — Philips Semiconductors reserves the right to make changes in the products - including circuits, standard cells, and/or software - described or contained herein in order to improve design and/or performance. When the product is in full production (status 'Production'), relevant changes will be communicated via a Customer Product/Process Change Notification (CPCN). Philips Semiconductors assumes no responsibility or liability for the use of any of these products, conveys no license or title under any patent, copyright, or mask work right to these products, and makes no representations or warranties that these products are free from patent, copyright, or mask work right infringement, unless otherwise specified.

Philips Semiconductors – a worldwide company

Contact information

For additional information please visit <http://www.semiconductors.philips.com>. Fax: +31 40 27 24825

For sales offices addresses send e-mail to: sales.addresses@www.semiconductors.philips.com.

© Koninklijke Philips Electronics N.V. 2004

SCA76

All rights are reserved. Reproduction in whole or in part is prohibited without the prior written consent of the copyright owner.

The information presented in this document does not form part of any quotation or contract, is believed to be accurate and reliable and may be changed without notice. No liability will be accepted by the publisher for any consequence of its use. Publication thereof does not convey nor imply any license under patent- or other industrial or intellectual property rights.

Printed in The Netherlands

R76/04/pp11

Date of release: 2004 Jun 14

Document order number: 9397 750 13234

Let's make things better.

**Philips
Semiconductors**



PHILIPS